

17L
4213

Nissan NP300 Navara D23, Md. 2015+2019

EU-Personenschutzbügel 76 mm

EU-pedestrian protection bar 76 mm

Protection avant, homologuée CEE, 76 mm

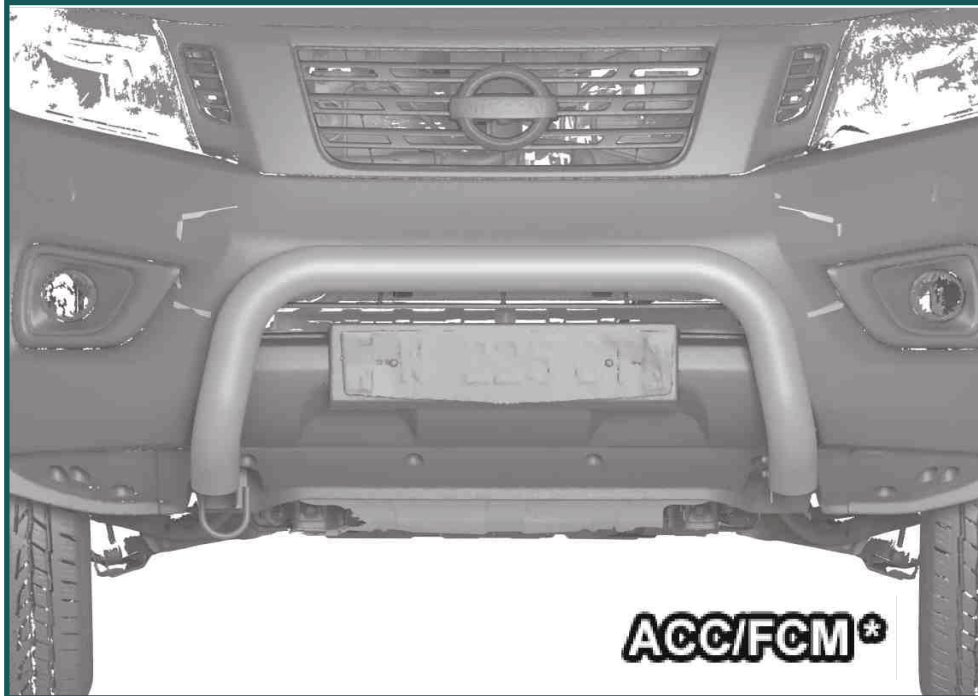

*Compatible with Automatic Cruise Control /Forward Collision Mitigation
Kompatibel mit Abstandsregeltempomat /Auffahrvermeidungs-oder warnsystem
compatible avec radar de régulation de distance/ freinage autonome d'urgence



ASSEMBLY INSTRUCTION

Montageanleitung • Instructions de montage

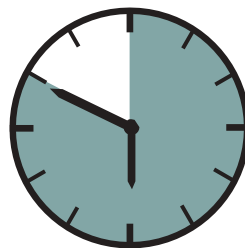

50 Minuten

article no.:

17L4213 (S) inox

17L5213 black steel

Revision 4: 25.09.2019



ULLSTEIN
CONCEPTS
GMBH

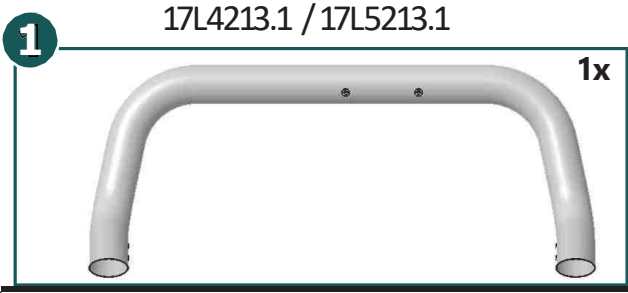
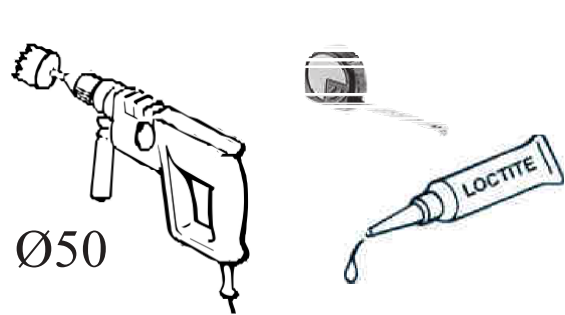
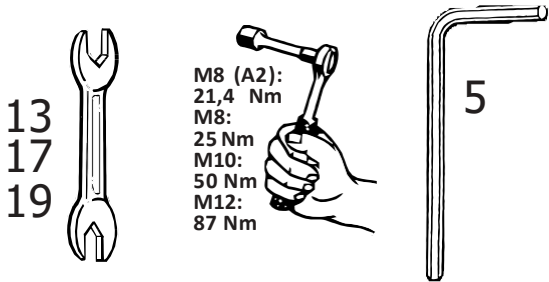

mounting kit: 17L9213

	M8x20; ähnl. ISO 7380 A2	4x
	M8; DIN 934 Zn	2x
	M8x25; DIN 933 A2	2x
	M12x55; DIN 933 Zn	1x
	M10; DIN 934 Zn	2x
	M12; DIN 934 Zn	1x
	Ø 8,4; DIN 125 Zn	2x
	SW13	2x

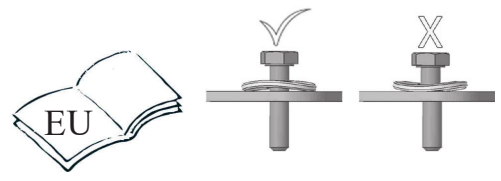
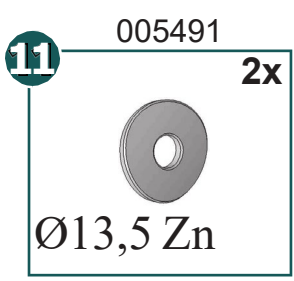
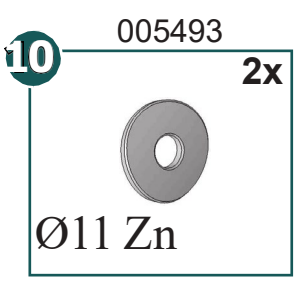
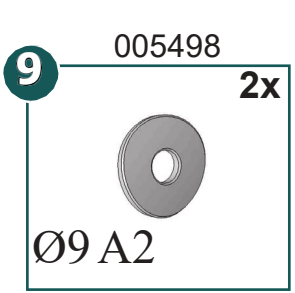
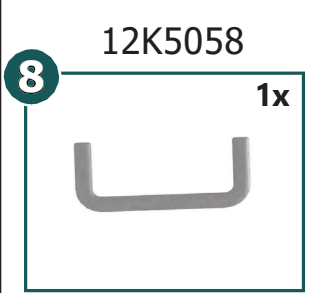
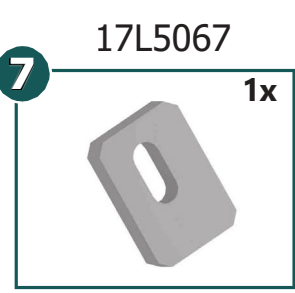
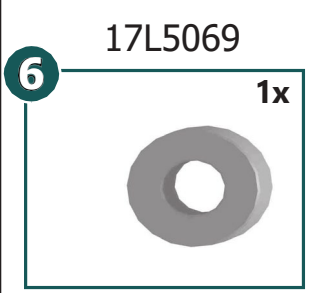
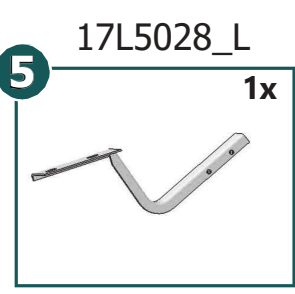
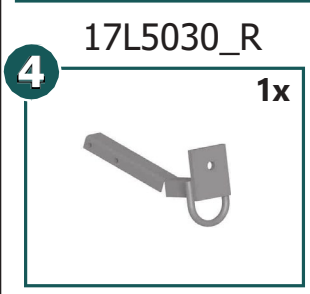
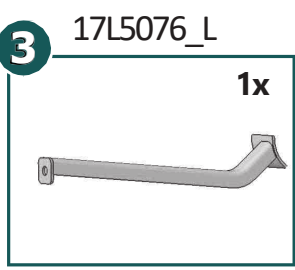
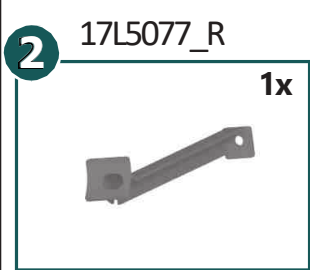

article no.:
17L4213 (S) inox
17L5213 black steel

Revision 4: 25.09.2019



ULLSTEIN
CONCEPTS
GMBH

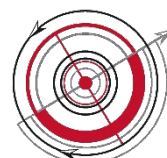
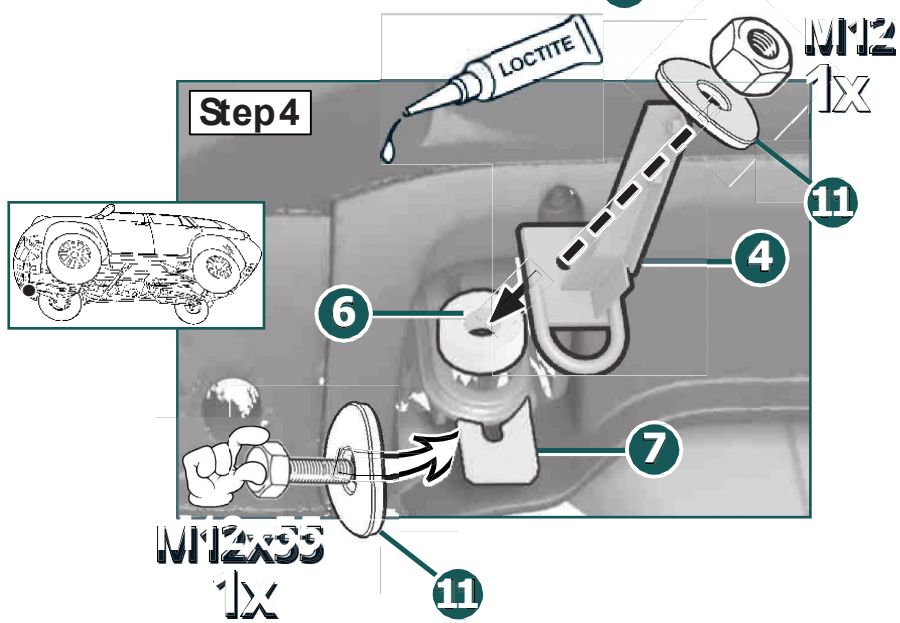
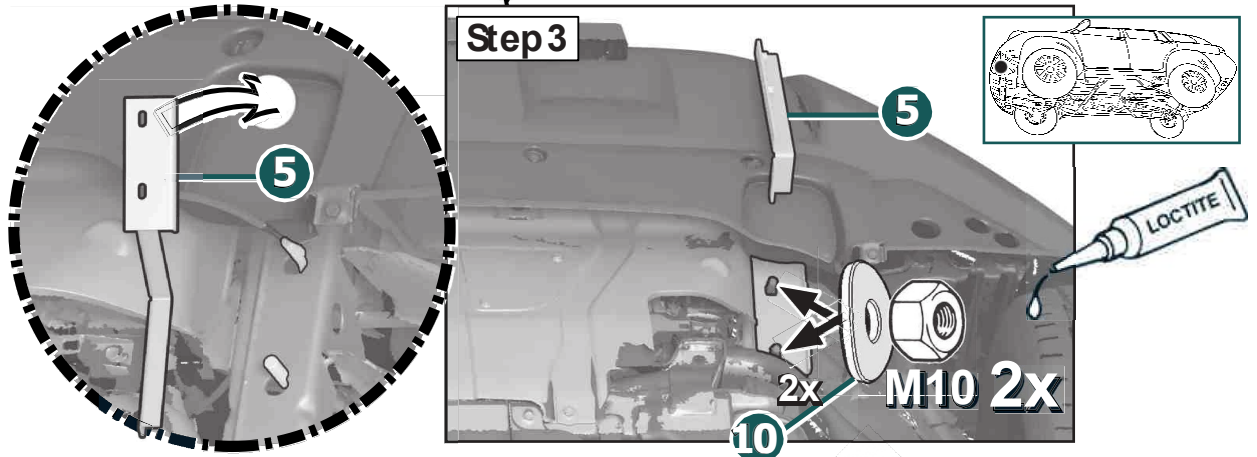
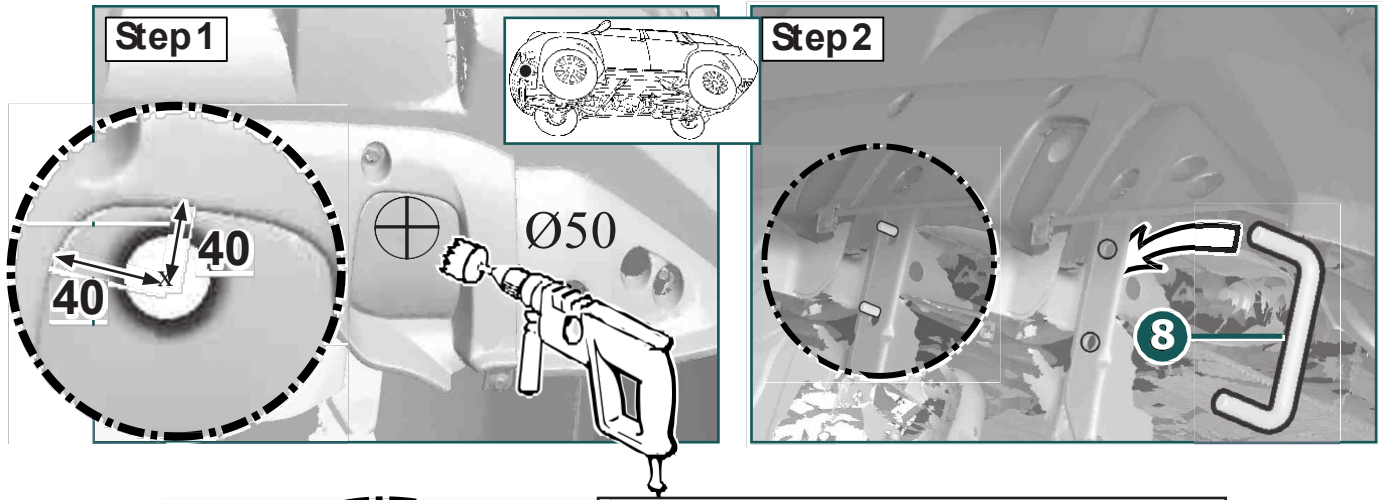

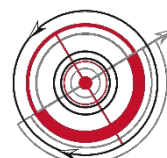
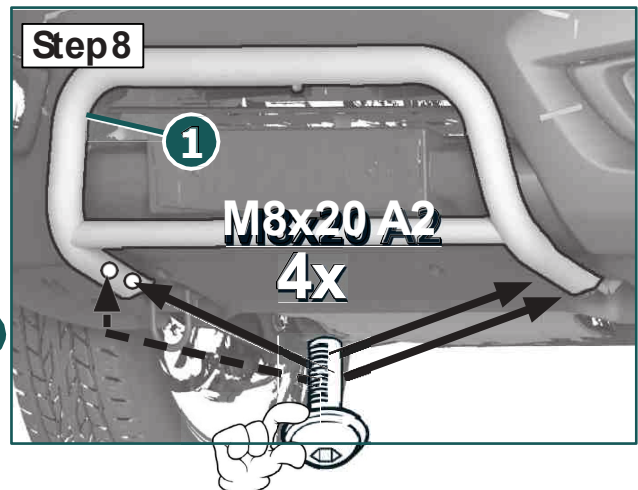
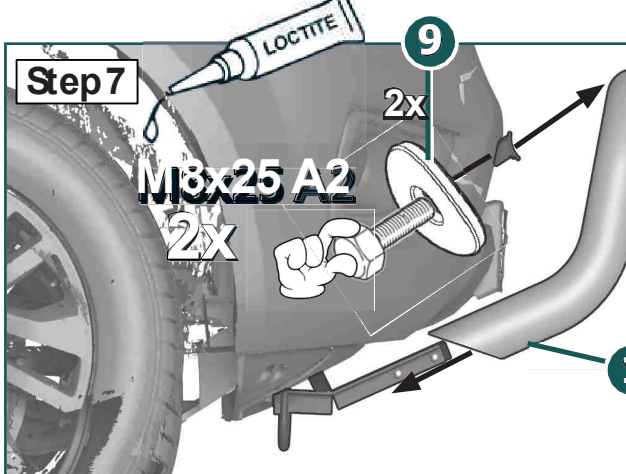
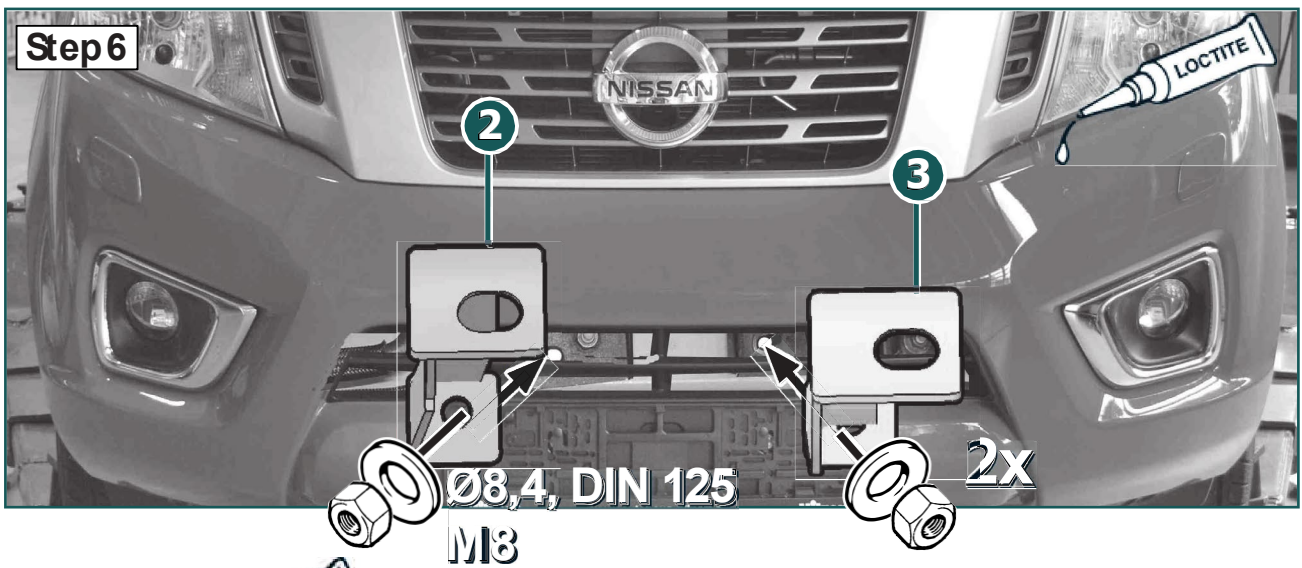
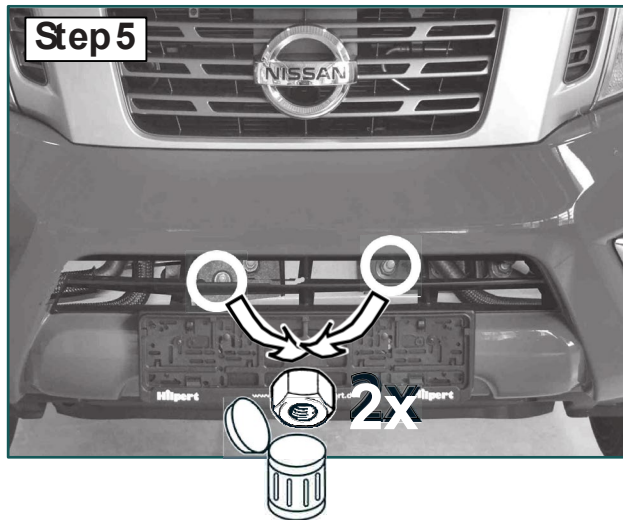

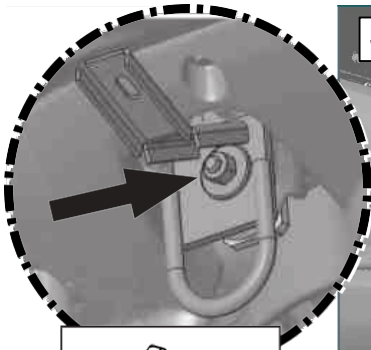

M8 (A2):
21,4 Nm
M8:
25 Nm
M10:
50 Nm
M12:
87 Nm

