

204500110

Mercedes X-Klasse, Md. 2016

EU-Pedestrian Protection Bar 76 mm

EU-Personenschutzbügel 76 mm

Protection avant, homologuée CEE, 76 mm



*Compatible with Automatic Cruise Control /Forward Collision Mitigation
Kompatibel mit Abstandsregeltempomat /Auffahrvermeidungs-oder warnsystem
compatible avec radar de régulation de distance/ freinage autonome d'urgence



ASSEMBLY INSTRUCTION

Montageanleitung • Instructions de montage

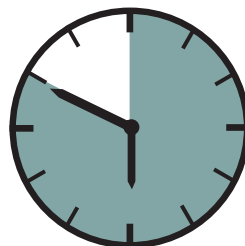

50 Minuten

Revision 3: 22.03.2018
Anleitung-Nr.:7500077



ULLSTEIN
CONCEPTS
GMBH

www.ullsteinconcepts.com

10
13
17
19

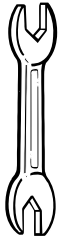

M6:
10 Nm
M8 (A2):
21,4 Nm
M8:
25Nm
M10:
50 Nm
M12:
87 Nm

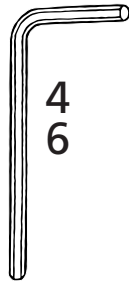
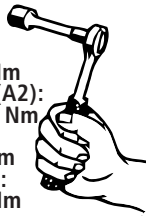



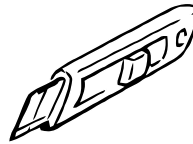



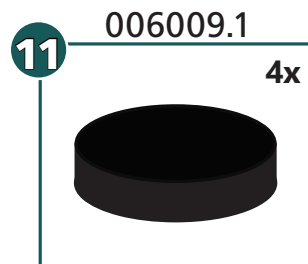
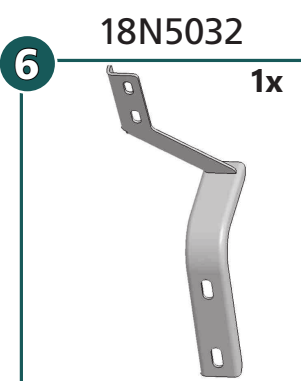
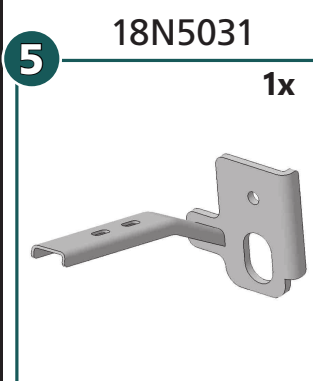
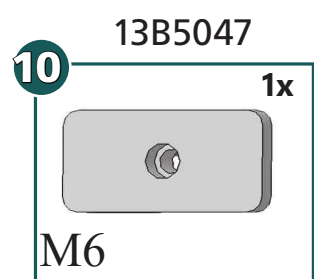
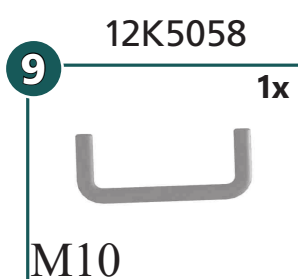
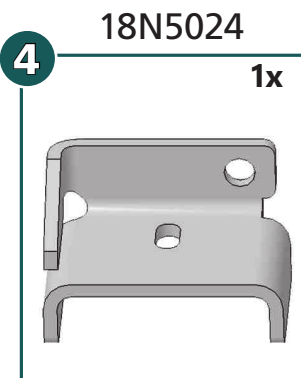
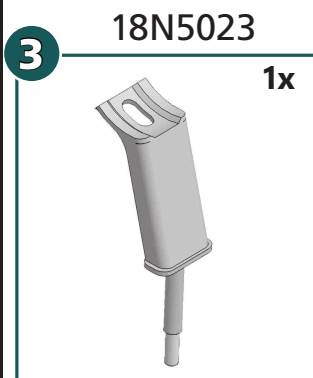
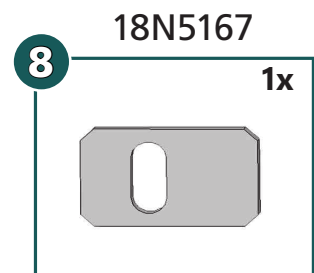
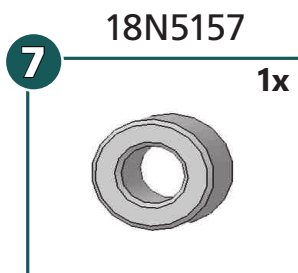
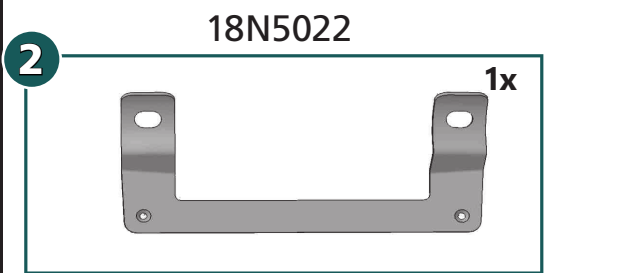



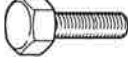

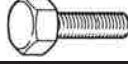
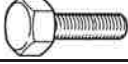





4
6



mounting kit: 18N9413



mounting kit: 18N9413

	M6x20; DIN 7991 Zn	2x
	M6x20; DIN 933 Zn	1x
	M8x25; DIN 912 A2	4x
	M8x25; DIN 933 A2	3x
	M12x60; DIN 933 Zn	1x
	M8; DIN 934 Zn	1x
	M10; DIN 934 Zn	2x
	M12; DIN 934 Zn	1x
	Ø 6; DIN 127 Zn	1x
	Ø 8; DIN 127 A2	7x
	Ø 8; DIN 127 Zn	1x
	Ø 10; DIN 127 Zn	2x
	Ø 12; DIN 127 Zn	1x
	Ø 6,4; DIN 9021 Zn	1x
	Ø 8,4; DIN 9021 A2	3x
	Ø 8,4; DIN 125 A2	4x
	Ø 8,4; DIN 125 Zn	1x
	Ø 10,5; DIN 9021 Zn	2x
	Ø 13; DIN 9021 Zn	2x
	SW 13	3x

