

**15U  
4213**

## Isuzu D-Max; Md.2012

EU-Pedestrian Protection Bar 60 mm  
EU-Personenschutzbügel 60 mm  
Protection avant, homologuée CEE, 60 mm



# ASSEMBLY INSTRUCTION

Montageanleitung • Instructions de montage



45 Minuten

**Artikel-Nr.:**

15U4213 Stainless Steel  
15U5213 black Steel

**Revision 2:** 21.11.2014

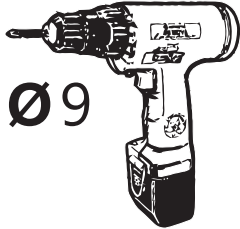
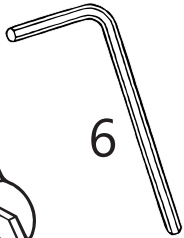
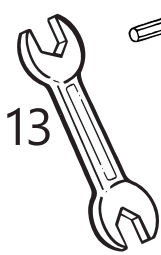

M8 (A2):  
21,4 Nm  
M8:  
25 Nm

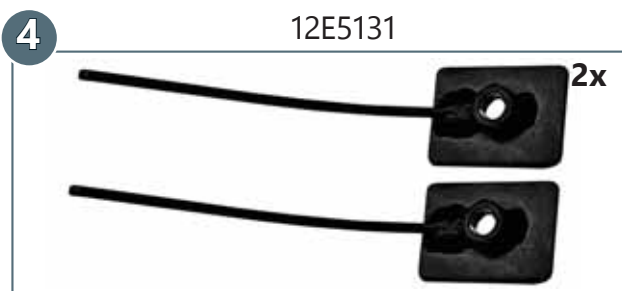
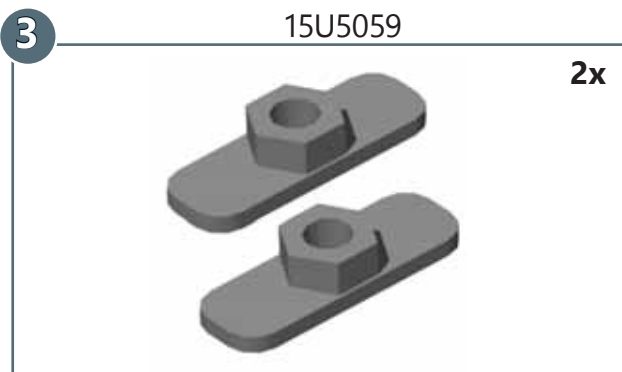
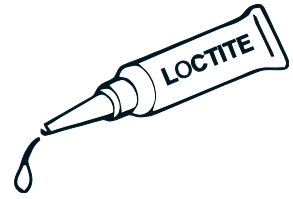
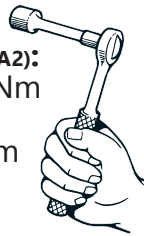

<b>a</b>		M8 x 25; DIN 912 A2	<b>2x</b>
<b>b</b>		M8 x 25; DIN 933 A2	<b>2x</b>
<b>c</b>		M8 x 30; DIN 933 Zn	<b>2x</b>
<b>d</b>		Ø 8,4; DIN 9021 A2	<b>2x</b>
<b>e</b>		Ø 8,4; DIN 125 Zn	<b>2x</b>
<b>f</b>		Ø 8; DIN 125 A2	<b>2x</b>
<b>g</b>		Ø 8; DIN 127 Zn	<b>2x</b>
<b>h</b>		SW 13	<b>4x</b>



