



TOYOTA HI-LUX EXTRA CAB 2016



Item Code

GPO/418/IX

Codice Articolo

DSP/418/IX

Référence Article

GB

STAINLESS STEEL OVAL SIDE
PROTECTIONS/DESIGN SIDE PROTECTIONS

ITA









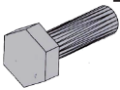

GRAN PEDANA OVALE/PROTEZIONI
LATERALI DESIGN IN ACCIAIO INOX

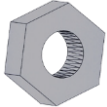
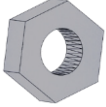
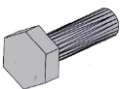
FR

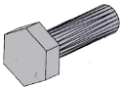
GRAND MARCHEPIED OVALE/ PROTECTIONS
LATERALES DESIGN EN ACCIER INOX

TOYOTA HI-LUX EXTRA CAB 2016

Part List
Lista della bulloneria
Liste des pièces

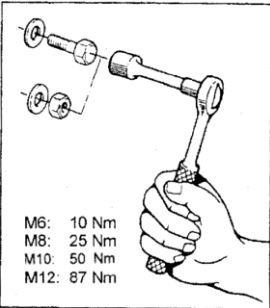
A  TE M10X25 x 8	B  Ø 10 x 8	C  Ø 10 x 8	D  M10 x 8	E  M 8 x 2
F  TE M8X30 x 4	G  BIG Ø 8 GRANDE x 16	H  Ø 8 x 16	I  TE M8X20 x 8	L  GPO/410/A x 4
M  P/410/B x 2	N  P/410/C x 2	 Cappelletti M10 x 16	 Cappelletti M 8 x 8	
				 <p>M6: 10 Nm M8: 25 Nm M10: 50 Nm M12: 87 Nm</p>

TOYOTA HI-LUX EXTRA CAB 2016

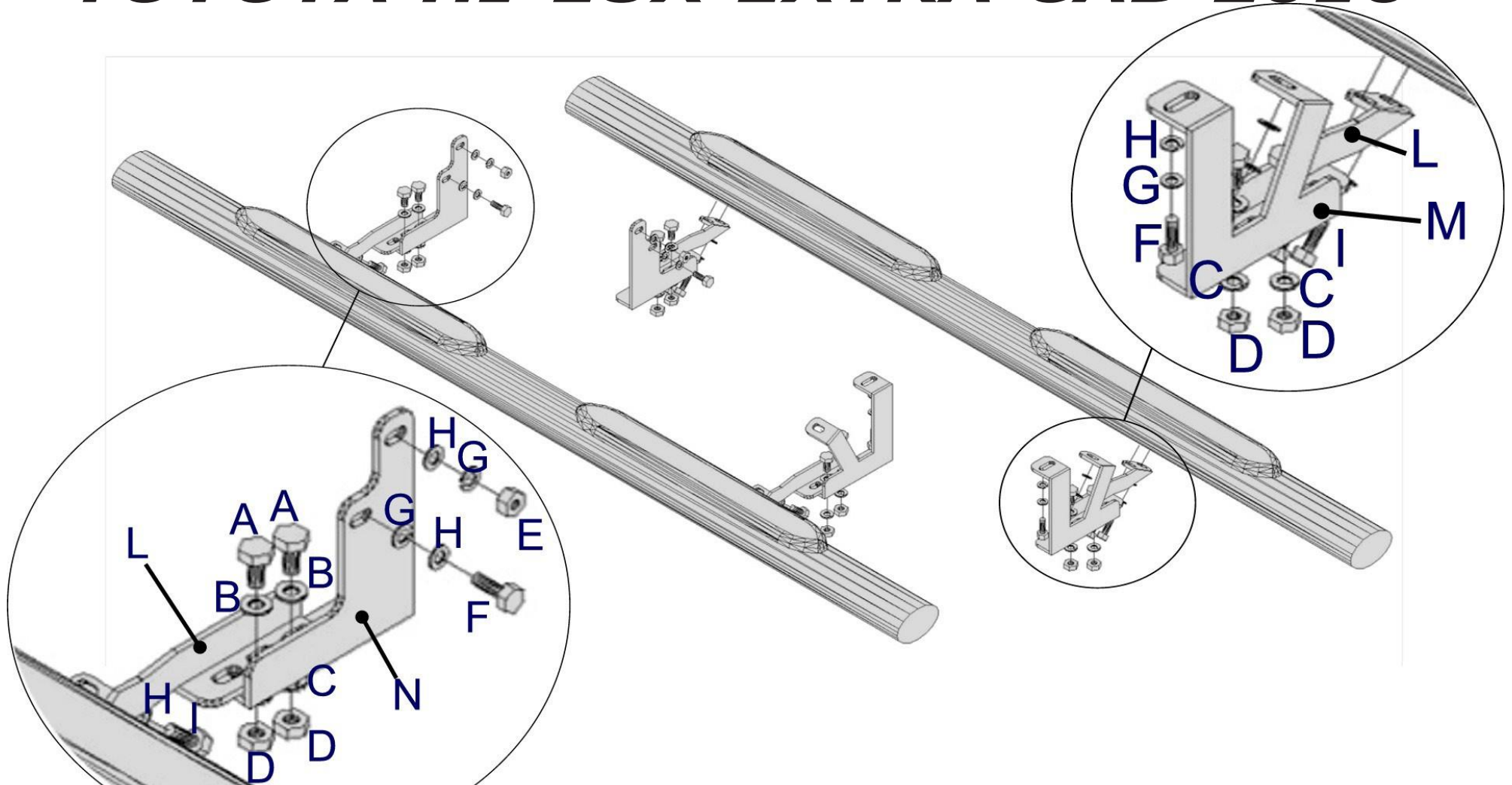

**lubricate the set of bolts
supplied before tightening
them**

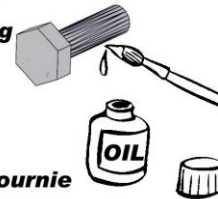

**Si consiglia di lubrificare
la bulloneria in dotazione
prima del settaggio**

**Lubrifier la boulonnerie fournie
avant de la serrer**





1



2



3



4



5



6

Date Data <i>Date</i> <i>Datum</i>	Item Code Cod.Articolo <i>Réf. Article</i> <i>Artikelbezeichnung</i>	Vehicle model Modello Veicolo <i>Modèle de Voiture</i> <i>Fahrzeugmodell</i>
06/06/16	DSP/418/IX GPO/418/IX	HI-LUX EXTRA CAB 2016

Document checked and approved by
Documento controllato ed approvato da
Document contrôlé et approuvé par
Dokument überprüft und freigegeben durch

BOTTA PIETRO



Date Data <i>Date</i> <i>Datum</i>	Item Code Cod.Articolo <i>Réf. Article</i> <i>Artikelbezeichnung</i>	Vehicle model Modello Veicolo <i>Modèle de Voiture</i> <i>Fahrzeugmodell</i>
06/06/16	DSP/418/IX GPO/418/IX	HI-LUX EXTRA CAB 2016

Document checked and approved by
Documento controllato ed approvato da
Document contrôlé et approuvé par
Dokument überprüft und freigegeben durch

BOTTA PIETRO